

Myriad V Solid State Pendant - Silver - Remote Gear

MYRIAD PENDANT 3000K REMOTE EB SIL
2050691



Product features

- High-end architectural (3000K) warm white LED pendant with non dimmable driver and remote gear housing, finished in a silver finish (RAL9006)



PRODUCT OVERVIEW

IPC Code	2050691
Product name	MYRIAD PENDANT 3000K REMOTE EB SIL
Technology	LED
Mount	Ceiling pendant
Environment	Interior
General application	Hospitality,Office,Retail,Residential & Consumer
Certifications	EUNEW008
ETIM Class	EC001743
Fixture luminous flux (lm)	1114
Luminaire efficacy (lm/W)	111.4
LOR (%)	100
Colour temperature (K)	3000
CRI (Ra)	80
Beam Angle (°)	30
Photobiological Risk Group	-
Total power consumption (W)	10
Electrical protection	Class II
Control gear mounting	Remote

Myriad V Solid State Pendant - Silver - Remote Gear

MYRIAD PENDANT 3000K REMOTE EB SIL
2050691

Dimmable	No
Housing colour	Silver
IP rating	IP20
IK rating	IK02
Product EAN number	5025768506910
Included lamp	INTEGRATED LED

DATA TABLE

General data

IPC Code	2050691
Product name	MYRIAD PENDANT 3000K REMOTE EB SIL
Technology	LED
Mount	Ceiling pendant
Environment	Interior
General application	Hospitality,Office,Retail,Residential & Consumer
Certifications	EUNEW008
ETIM Class	EC001743

Optical data

Fixture luminous flux (lm)	1114
Luminaire efficacy (lm/W)	111.4
LOR (%)	100
Colour temperature (K)	3000
CRI (Ra)	80
Adjustable chromaticity	N
Beam Angle (°)	30
Distribution type	Direct symmetrical
Photobiological Risk Group	-

Electrical data

Total power consumption (W)	10
Mains voltage (V)	220-240V~
Electrical protection	Class II
Control gear mounting	Remote
Dimmable	No
Drive current (mA)	250
Nominal Frequency (Hz)	50/60Hz

Lifetime data

Lumen maintenance - L70 B50	50000
-----------------------------	-------

Physical data

Housing colour	Silver
IP rating	IP20
IK rating	IK02
Nominal Product Length (mm)	75
Nominal Product Width (mm)	75

Myriad V Solid State Pendant - Silver - Remote Gear MYRIAD PENDANT 3000K REMOTE EB SIL 2050691

Nominal Product Height (mm)	129
Nominal Product Diameter (mm)	75
Max. Lamp Diameter (mm) - D	75
Weight (kg)	0.45

Packaging

Single packaging type	Carton
Product EAN number	5025768506910
Packaging single length / height (cm)	17.5
Packaging single width (cm)	15.0
Packaging single depth (cm)	17.5
Units per outer package	1
Packaging outer length / height (cm)	17.5
Packaging outer width (cm)	15.0
Packaging outer depth (cm)	17.5

PHOTOMETRY

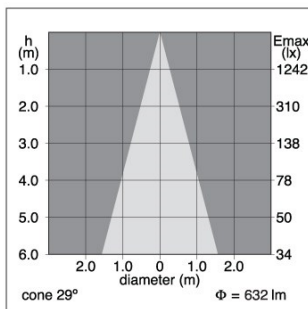

3000K

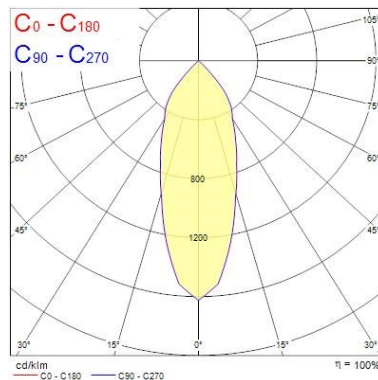
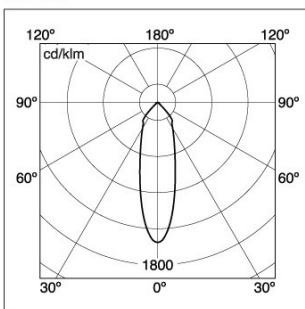

Myriad V Solid State Pendant - Silver - Remote Gear

MYRIAD PENDANT 3000K REMOTE EB SIL
2050691

0.5	0.33	E(0°) E(C0)	18.5°	7241 3101
1.0	0.67	E(0°) E(C0)	18.5°	1810 775
1.5	1.00	E(0°) E(C0)	18.5°	805 345
2.0	1.34	E(0°) E(C0)	18.5°	483 194
2.5	1.67	E(0°) E(C0)	18.5°	290 124
3.0	2.01	E(0°) E(C0)	18.5°	201 85

Distance [m] Cone diameter [m] Illuminance [lx]

C0 - C180 (Half beam angle: 37.0°)

TECHNICAL DRAWINGS

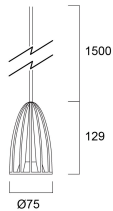

Myriad V Solid State Pendant - Silver - Remote Gear MYRIAD PENDANT 3000K REMOTE EB SIL 2050691

Concord 2050691

 This luminaire contains built in LED lamps.

 } **LED**

The lamps cannot be changed in the luminaire.

874/2012 

 This luminaire contains built in LED lamps.

 } **LED**

The lamps cannot be changed in the luminaire.

Concord 2050691  874/2012