

DDC4040e automation station

Application

Controller with BACnet communication

- Stand-alone station for closed-loop and open-loop control, optimizing and monitoring functions
- Customizable plain text for every parameter
- 12 DDC closed-loop control plants for heating and ventilation, can be expanded with software objects
- PLC functions, free and as fixed macros (hardware objects)
- Software objects for increasing energy efficiency and energy optimization
- Communication
 - Via TCP/IP, Ethernet cable (min. Cat5, 10/100 Mbit) to enable use of the existing infrastructure
 - Built-in remote control via PC with browser without additional software or mobile end devices
 - Native BACnet in accordance with DIN EN ISO 16484-5, BACnet IP and BACnet MS/TP
 - Up to 99 DDC4000 automation stations with bidirectional data exchange
- 2 buses (CAN-based), configurable for switch cabinet bus or fieldbus for connecting fieldbus modules (FBM/FBU or RBW4xxx) or switch cabinet bus modules BMD/BMA or SBM
- Error message memory, event logging with date and time, incoming and outgoing messages are saved
- Forwards messages to GSM-SMS and e-mail.
- Trend value memory for max. 100.000 trend points.
- Configuration using modern, effective object structure, considerably reducing project planning time.
- Embedded Linux operating system for proven, stable use
- Constant system monitoring of the bus communication and all connected DDC components, bidirectional data exchange possible.

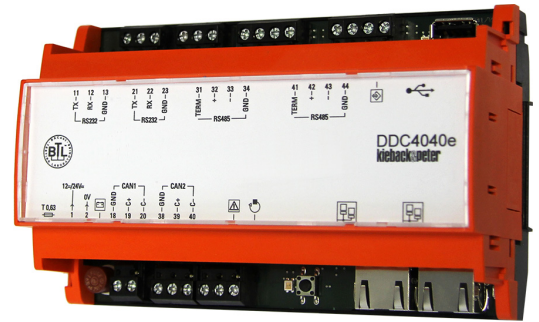

Content	Page
Important Information Regarding Product Safety	2
Item	3
Technical Data	3
Dimensions	4
Accessories (included in delivery)	4
Accessories (not included in delivery)	4
Connection	5
Connectible modules	6
Installation	7
Mounting	8
Removal	8
Push buttons and LED displays	9

Änderungen vorbehalten - Contents subject to change - Sous réserve de modifications - Reservado el derecho a modificación - Wijzigingen voorbehouden - Con riserva di modifiche - Innehåll som skall ändras - Zmeny vyhradené - Změny vyhrázeny - Zmiany zastrzeżone - Возможны изменения - A változtatások jogát fenntartjuk - 保留未经通知而改动的权力

Important Information Regarding Product Safety

Safety Instructions

This data sheet contains information on installing and commissioning the product "DDC4040e". Each person who carries out work on this product must have read and understood this data sheet. If you have any questions that are not resolved by this data sheet, you can obtain further information from the supplier or manufacturer.

If the product is not used in accordance with this data sheet, the protection provided will be impaired.

Applicable regulations must be observed when installing and using the device. Within the EU, these include regulations regarding occupational safety and accident prevention as well as those from the VDE (Association for Electrical, Electronic & Information Technologies). If the device is used in other countries, it is the responsibility of the system installer or operator to comply with local regulations.

Mounting, installation and commissioning work on the devices may only be carried out by qualified technicians. Qualified technicians are persons who are familiar with the described product and who can assess given tasks and recognize possible dangers due to technical training, knowledge and experience as well as knowledge of the appropriate regulations.

Legend



WARNING

Indicates a hazard of medium risk which can result in death or severe bodily injury if it is not avoided.



CAUTION

Indicates a hazard of low risk which can result in minor or medium bodily injury if it is not avoided.



CAUTION

Indicates a hazard of medium risk which can result in material damage or malfunctions if it is not avoided.



NOTE

Indicates additional information that can simplify the work with the product for you.

Notes on Disposal

For disposal, the product is considered waste from electrical and electronic equipment (electronic waste) and must not be disposed of as household waste. Special treatment for specific components may be legally binding or ecologically sensible. The local and currently applicable legislation must be observed.

Product Description**DDC4040e****Item**

DDC4040e Top hat rail mounted automation station

Technical Data

Nominal voltage	<ul style="list-style-type: none"> ■ 24V AC +/- 10 %; 50..60 Hz; 20 VA; 0,83 A or ■ DC 24 V +/- 10%; 13 W; 0.54 A or ■ 12V DC +/-10 %; 13 W; 1,08 A
Fuses	Time-delay power fuse, 0.63 A
Bus connection / interfaces	<ul style="list-style-type: none"> ■ 2 Ethernet RJ45 internally as a switch Enables operation of up to 99 DDC4000 automation stations, users can establish worldwide network via active network components, BMS and BACnet client connection, 10/100 Mb/s, TCP/IP ■ 2 CAN buses, configurable as fieldbus or switch cabinet bus <ul style="list-style-type: none"> - fieldbus, F-bus: up to 63 FieldBusModules FBM/FBU or up to 40 RBW4xxx, 2000 m, 20 kBd, CAN, see page 6 - Switch cabinet bus; SBM bus: up to 16 switch cabinet bus modules SBM or BMA/BMD, 200 m; 40 kBd, CAN, see page 6 ■ USB socket For USB stick only: Update, backup/restoration ■ 2 serial RS232 <ul style="list-style-type: none"> - 1 for LON FTT-10 (terminals "11", "12", "13") - 1 for modem (terminals "21", "22", "23") ■ 2 RS485 <ul style="list-style-type: none"> - 1 for BACnet MS/TP (terminals "32", "33", "34") 32 devices, 1000 m, up to 115 kBd, routing in accordance with BACnet/IP

**CAUTION**

Only connect USB memory sticks to the USB socket. Do not connect any other USB devices.

**NOTE**

The CAN-bus fieldbus offers 63 bus addresses and the switch cabinet bus offers 16 bus addresses. The maximum number of connectible input/output modules depends on the selected device types. Further information can be found in the DDC4000 project planning documentation.

Total memory	4 GB flash; 512 MB RAM
Operating system	Embedded Linux
Mains failure data backup	via internal mini USV
Overvoltage category	III
Rated impulse voltage	800V
Level of contamination	2
Method of operation	Type 1
Degree of protection	IP20
Ambient temperature	0..55 °C (see installation note, p.7)

DDC4040e

Product Description

Ambient humidity	During operation: 20%..80% r.h., non-condensing Out of operation: 5% to 90% r.h., non-condensing
Mounting	Switch cabinet top hat rail TH 35-7.5 This device is intended for installation in a wall-mounted enclosure or switch cabinet with protection class I or II.
Dimensions	WxHxD 143,3 x 90 x 60 mm
Weight	0.26 kg

Dimensions

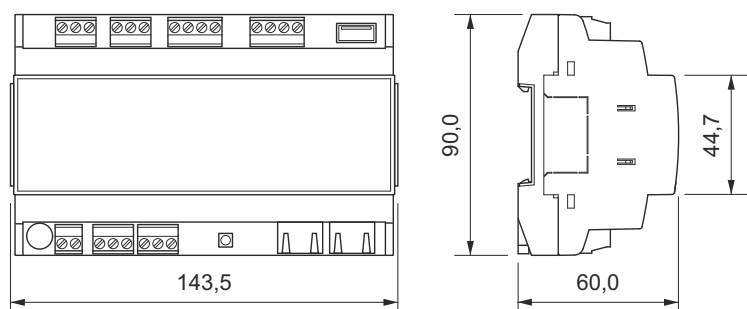

Accessories (included in delivery)

USBSTICK-DDC-MINI USB stick

Accessories (not included in delivery)

DDC4N-LON RS232-LON adapter
Data sheet 2.60-10.230-01 provides more information (included with the DDC4N-LON accessories).

Product Description

DDC4040e

Connection

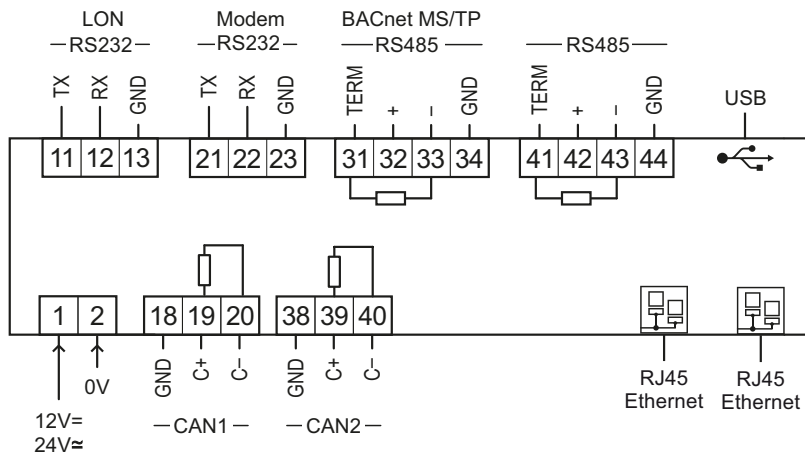

CAUTION

Ensure that no third persons can access your data during data transfer.
Only use secure solutions when connecting to public networks (VPN).



CAUTION

Use secure passwords to protect your data, devices and plants from unauthorized access. A secure password consists of lowercase and uppercase letters, numbers and special characters. It must also be long enough.

Change the passwords directly after transfer of the plant, commissioning of the device or importing software. Change the passwords at regular intervals. Use different passwords.

You are responsible for the security of your data and/or plant.

Connectible modules

- Maximum number of fieldbus modules that can be installed up to 63 FieldBusModules FBM/FBU or up to 40 RBW4xxx

Module	Number
FBG-FTL	16
FBK36	40
FBM018	63
FBM024	63
FBM034	63
FBM044	63
FBM18	63
FBM24	63
FBM34	63
FBM38	63
FBM44	63
FBM45	63
FBU410	30
MD200BUS	40
RBW420x	40
RBW430x	40

- Maximum number of switch cabinet bus modules that can be installed up to 16 switch cabinet bus modules SBM or BMA/BMD

Module	Number
BMA4024	16
BMA4032	16
BMD4064	16
SBM41	16
SBM42	16
SBM45	16
SBM51/xx	5
SBM52/04	1

Further information can be found in the DDC4000 project planning documentation.

Installation



CAUTION

Switching on the power supply of unparameterized products can lead to unforeseen consequences such as malfunctions or material damage.

Switch on the power only after the device has been configured by the commissioning technician.

CAN bus

When connecting the CAN bus, use a cable with 2 x 2 leads stranded into a pair with plastic insulation and electrostatic shielding with a lead diameter of at least 0.8 mm. Use a stranded pair of wires for the data lines (+ and -) and another free wire for the ground (0).

At the end of the CAN bus (furthest point from the controller), install a terminating resistor of about 180 ohms between the two data lines (+ and -). The terminating resistor is included with the controller.

- When using CAN bus as a fieldbus, the maximum cable length is 2,000 m.
- When using CAN bus as a switch cabinet bus, the maximum cable length is 200 m.
- Make sure to observe the line topology for the CAN bus.

RS485 for BACnet MS/TP

To connect the MS/TP bus, use at least one cable of the type JY(St)Y 2x2x0.8 Lg:

Two x two leads stranded into a pair with plastic insulation and electrostatic shielding with a lead diameter of at least 0.8 mm and a characteristic impedance between 100 and 130 ohms.

Use a stranded pair of leads for the data lines and another free lead for the ground connection.

Observe the polarity of the data lines of the MS/TP. Terminal "33" supplies the inverted signal, it is usually labeled with -. Terminal "32" supplies the non-inverted signal, it is usually labeled with +. Terminal "34" is used for the ground connection.

At the start and end of the MS/TP bus, install a terminating resistor of ideally about 120 ohm between the two data lines.

The DDC4040e has an integrated 120 ohm resistor. It can be activated by means of a bridge between the terminals "32" + and "31" TERM.

Foreign devices often enable a switchable terminating resistor. Refer to the data sheet or the respective manufacturer's manual for further information.

Use bias resistors to maintain the bus idle level at a defined high level and to prevent noise being misinterpreted as a data signal. We recommend that you use network bias resistors on the first and last device on the bus.

A maximum of 2 devices on the bus may be equipped with network bias resistors.

The DDC4000 is fitted with a 680 ohm bis resistor that can be activated via configuration. Further information can be found in the DDC4000 project planning documentation

Foreign devices often offer optionally switchable bias resistors.

- The maximum possible bus length is 1000 m.
- A maximum of 32 devices can be operated on a bus segment.
- Observe the line topology for the RS485 bus.

Mounting



WARNING

Contact with live parts of electrical domestic installation can cause death due to electric shock. Mounting/removal may only be carried out when power is switched off.



CAUTION

If the device is installed in false ceilings, the maximum permitted ambient temperature is 45 °C. Installation in floor boxes or similar systems is not permitted.

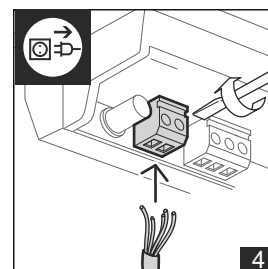
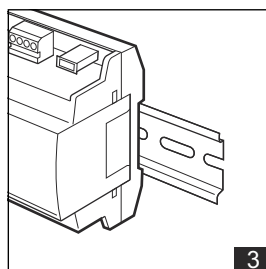
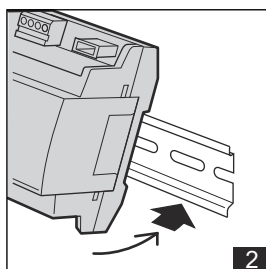
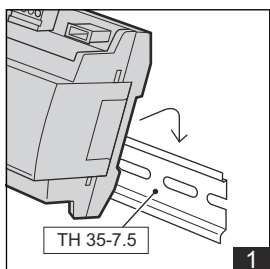
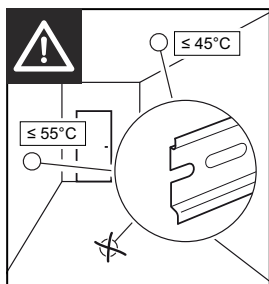

Removal

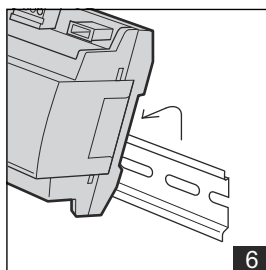
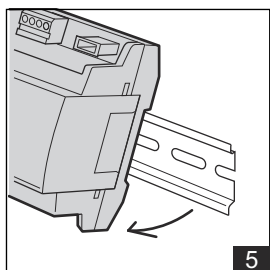
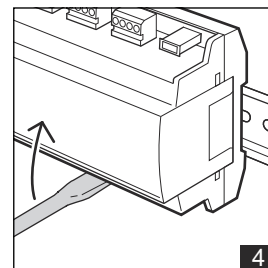
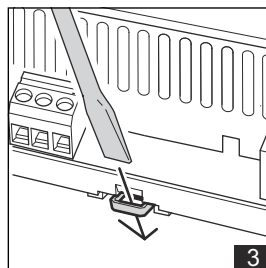
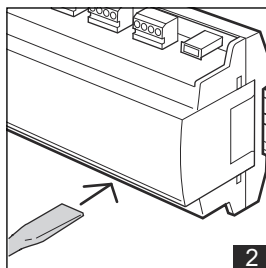
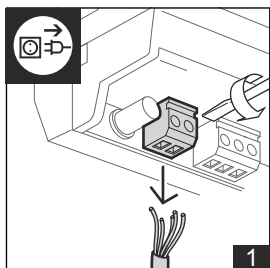

Push buttons and LED displays

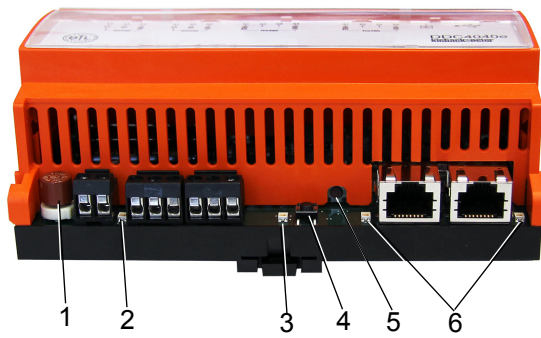

- (1) Mains fuse
- (2) Status LED nominal voltage
- (3) Status-LED internal data storage
- (4) Warm start push-button
- (5) Reset button
- (6) Status-LED Ethernet RJ45

