

TALEXdriver LCU 60W 12/24V IP20 EXC
EXCITE series

Product description

- Constant voltage LED Driver
- Universal input voltage range
- Constant output voltage
- Push terminals for simple wiring
- Nominal life-time up to 50,000 h (at ta 45 °C with a failure rate max. 0.2 % per 1,000 h)
- 5-year guarantee
- Suitable for emergency installations according to EN 50172
- Complies with CLASS C from minimum to maximum load range according to EN 61000-3-2



Properties

- Small design
- High efficiency
- Low power loss
- Overtemperature and overload protection
- Short-circuit shutdown feature with automatic restart
- Protection class II, SELV
- Type of protection IP20
- Plastic casing white



IP20 SELV Class 2 
 RoHS

TALEXdriver LCU 60W 12/24V IP20 EXC EXCITE series

Technical data

Rated supply voltage	100 – 277 V
Input voltage, AC	90 – 305 V
Input voltage, DC	176 – 288 V
Rated current (at 230 V 50 Hz)	0.32 A
Mains frequency	0 / 50 / 60 Hz
Efficiency	> 85 %
λ (at 230 V 50 Hz)	0.95
Output voltage tolerance 12 V	-0 / +10 %
Output voltage tolerance 24 V	-0 / +5 %
Output power ($t_a \leq 50$ °C)	60 W
Output power ($t_a > 50$ °C)	42 W
Output power range	4,8 – 60 W
Turn on time (output)	≤ 0.5 s
Turn off time (output)	≤ 1 s
Hold on time at power failure (Output)	10 ms
Ambient temperature t_a	-25 ... +60 °C
Ambient temperature t_a (at life-time 50,000 h) [Ⓢ]	-25 ... +45 °C
Storage temperature	-40 ... +85 °C
Dimensions LxWxH	250 x 40 x 21 mm
Hole spacing D	223 mm

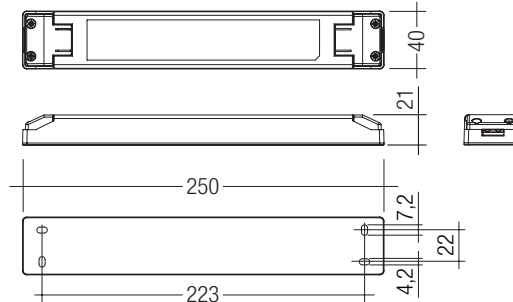

Ordering data

Type	Article number	Packaging carton	Packaging pallet	Weight per pc.
LCU 60W 12V SR TOP	28000407	20 pc(s).	1,500 pc(s).	0.29 kg
LCU 60W 24V SR TOP	28000412	20 pc(s).	1,500 pc(s).	0.28 kg

Specific technical data

Type	Max. casing temperature t_c	Output voltage	Max. input power	Output current range	Max. output voltage [Ⓢ]
LCU 60W 12V SR TOP	85 °C	12 V	74 W	0.4 – 5.0 A	13.2 V
LCU 60W 24V SR TOP	85 °C	24 V	74 W	0.2 – 2.5 A	25.2 V

[Ⓢ] For input voltage from 120 to 277 V AC (50 / 60 Hz) with 100 % load.
 For input voltage from 100 to 120 V AC (50 / 60 Hz) with 80 % load.

[Ⓢ] At failure mode (230 V, 50 Hz).

Standards

EN 55015
EN 60598-1
EN 60598-2-22
EN 61000-3-2
EN 61000-3-3
EN 61347-1
EN 61347-2-13
EN 61547
EN 62384
EN 62493
Acc. to EN 50172: suitabel for central battery systems

Overload protection

Automatic shutdown of the LED Driver if the maximum output current is exceeded.
Automatic restart if the output current is below the limit.

No-load operation

The LED Driver is not damaged in the no-load operation. The max. output voltage (see page1) can be obtained during no-load operation.

Over temperature protection

Automatic shutdown of the LED Driver if the temperature limit is exceeded.
Automatic restart if the temperature falls below the limit.

Short-circuit behaviour

In case of a short circuit on the secondary side (LED) the LED Driver switches into hiccup mode. After removal of the short-circuit fault the LED Driver will recover automatically.

Glow wire test

according to EN 61347-1 with increased temperature of 960 °C passed.

Expected life-time

Type	Output voltage	ta	40 °C	50 °C	60 °C
LCU 60W 12V SR TOP	12 V	tc	63 °C	73 °C	83 °C
		Life-time	> 75,000 h	> 50,000 h	> 25,000 h
LCU 60W 24V SR TOP	24 V	tc	75 °C	80 °C	85 °C
		Life-time	> 75,000 h	> 50,000 h	> 25,000 h

Maximum loading of automatic circuit breakers

Automatic circuit breaker type	C10	C13	C16	C20	B10	B13	B16	B20	Inrush current	
Installation Ø	1.5 mm ²	1.5 mm ²	1.5 mm ²	2.5 mm ²	1.5 mm ²	1.5 mm ²	1.5 mm ²	2.5 mm ²	I _{max}	time
LCU 60W 12V SR TOP	20	26	32	40	12	15	19	24	41,7A	105 µs
LCU 60W 24V SR TOP	14	18	22	28	8	10	13	16	46,6A	96 µs

Harmonic distortion in the mains supply (at 230V/50Hz and full load) in %

Type	THD	3	5	7	9	11
LCU 60W 12V SR TOP	9,8	2,4	1,4	0,9	0,8	0,3
LCU 60W 24V SR TOP	8	2	1,2	1	1	1

Wiring diagram

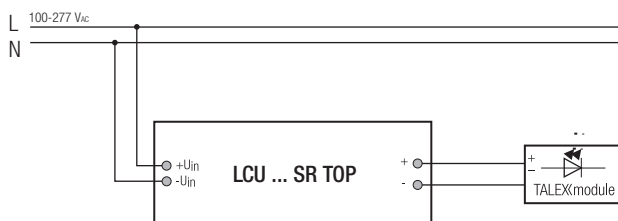

Installation instructions

The switching of LEDs on secondary side is not permitted.
A proper functioning of the LCU in combination with third party dimming devices (e.g. PWM) cannot be guaranteed.

Wiring type and cross section

The wiring can be in fine-stranded wires with ferrules. For perfect function of the terminals the strip length should be 9–10 mm for the terminal.

The maximum secondary cable length at the terminals is 2 m. The LED wiring should be kept as short as possible to ensure good EMC.

Input / Output terminal

PRI and SEC:
20 AWG – 16 AWG

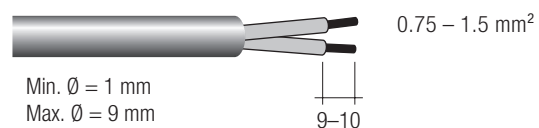

Release of the wiring:

The terminals have a simple push-in termination. Conductor removal via screw-driver (2.5 mm x 0.4 mm).

Insulation and electric strength testing of luminaires

Electronic devices can be damaged by high voltage. This has to be considered during the routine testing of the luminaires in production.

According to IEC 60598-1 Annex Q (informative only!) or ENEC 303-Annex A, each luminaire should be submitted to an insulation test with 500 V_{DC} for 1 second. This test voltage should be connected between the interconnected phase and neutral terminals and the earth terminal.

The insulation resistance must be at least 2 MΩ.

As an alternative, IEC 60598-1 Annex Q describes a test of the electrical strength with 1500 V_{AC} (or 1.414 x 1500 V_{DC}). To avoid damage to the electronic devices this test must not be conducted.

Additional information

Additional technical information at www.tridonic.com → Technical Data

Guarantee conditions at www.tridonic.com → Services

No warranty if device was opened.

Diagrams for 12 V

Efficiency vs load

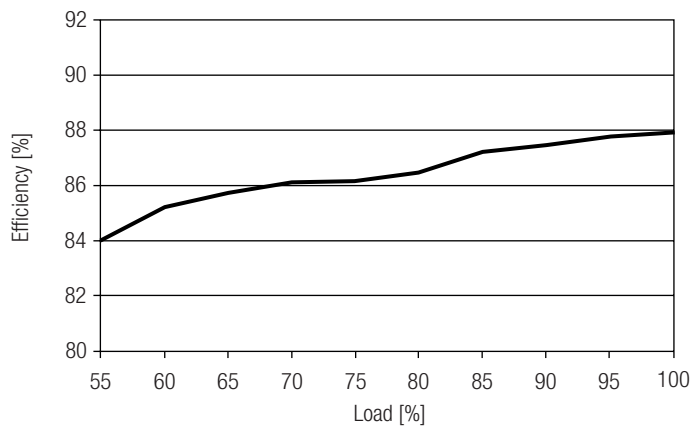

Power factor vs load

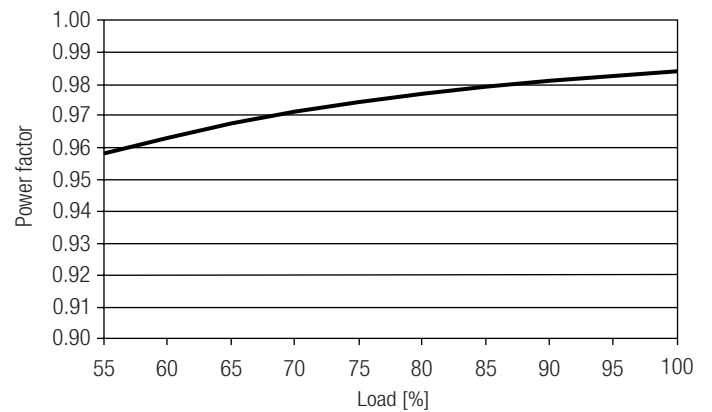

THD vs load

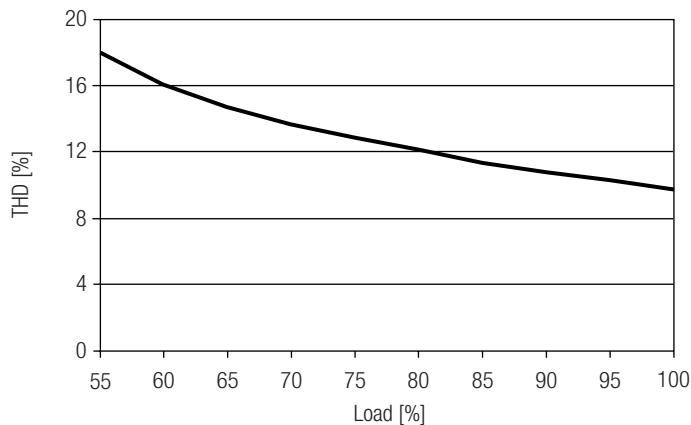

Diagrams for 24 V

Efficiency vs load

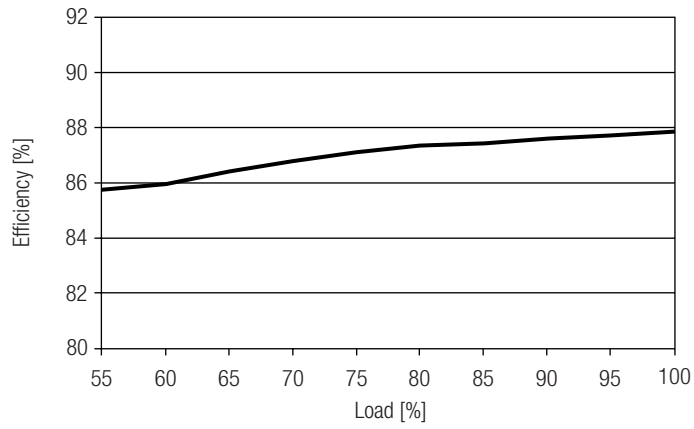

Power factor vs load

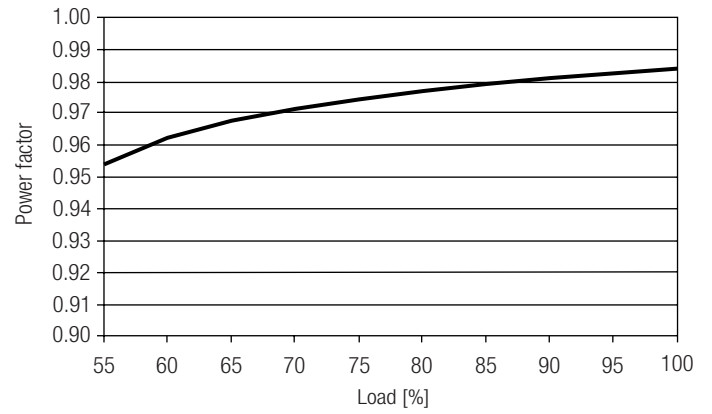

THD vs load

